



Instruction Manual for Outdoor Electric Series



MODELS: OE43*, OE169***, OE1610***, OE235*****

Thank you for purchasing a Severtson projection screen. Before use, please read the instructions carefully. After installation, store the instructions for future reference.

Overview

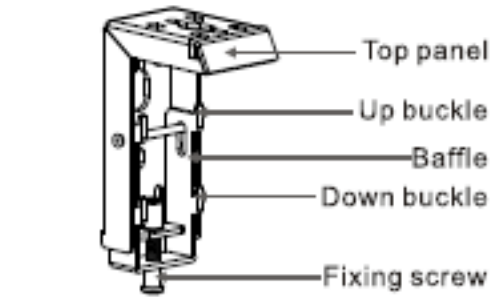
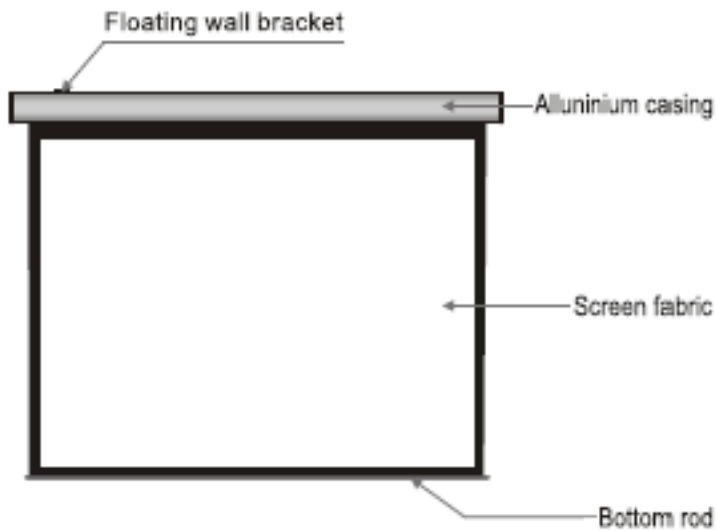

*Bracket design may vary

Parts Included

- Floating wall bracket (2pcs)
*Bracket design may vary

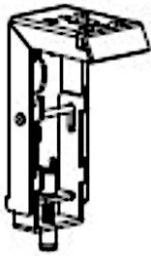

- $\varnothing 5 \times 40\text{mm}$ Tapping screw and anchor (8 sets)



- Ceiling hanger (2pcs)



- Rope (2pcs)



- Instruction manual (1pc)

- Stakes (2pcs)

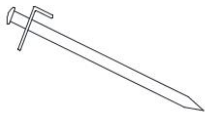

Installation Instructions

Take out all the parts from the packaging and verify that all the parts have been included, then follow the steps below to install the screen.

Note 1.1: When installing the projection screen it is important to choose the correct fasteners for the ceiling type. Choosing the wrong fasteners can lead to severe injuries or screen damage.

1. Remove any shipping tape or screws that are holding the weight bar.
2. Determine the desired mounting method and follow the correct procedure for installing the mounting brackets (*see Table 1.1 below*). Make sure the brackets are level before securing them in place. For hanging by wire installation, see *Note 1.2*.

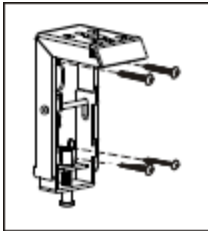
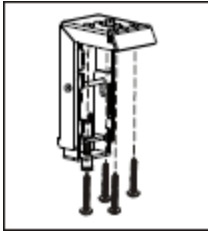
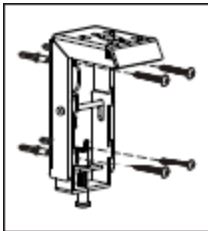
| Table 1.1 | | |
|---------------------|---|---|
| Mounting Method | Screw Placement | Instructions |
| Wood Framed Wall |  | Using four wood screws (5x40mm) for each bracket, secure each bracket to the wall. Make sure that the screws penetrate into the studs of the framed wall, otherwise the brackets will not be securely fastened. |
| Wood Framed Ceiling |  | Using four wood screws (5x40mm) for each bracket, secure each bracket to the ceiling. Make sure that the screws penetrate into the studs of the ceiling, otherwise the brackets will not be securely fastened. |
| Concrete Wall |  | Use an electric drill to drill four holes for each bracket and hammer the provided tapping anchors into each hole. Secure the brackets onto the wall by fastening the tapping screws (5x40mm) to the tapping anchors. |

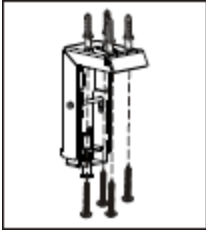
| | | |
|------------------|---|--|
| Concrete Ceiling |  | Use an electric drill to drill four holes for each bracket and hammer the provided tapping anchors into each hole. Secure the brackets onto the ceiling by fastening the tapping screws (5x40mm) to the tapping anchors. |
|------------------|---|--|

Note 1.2: To mount the screen to the ceiling by hanging wire, attach the wire-hanging attachments to the standard mounting brackets using the included screws (M5x10). The wire can now be strung through the additional loops in the brackets (*see images below*).

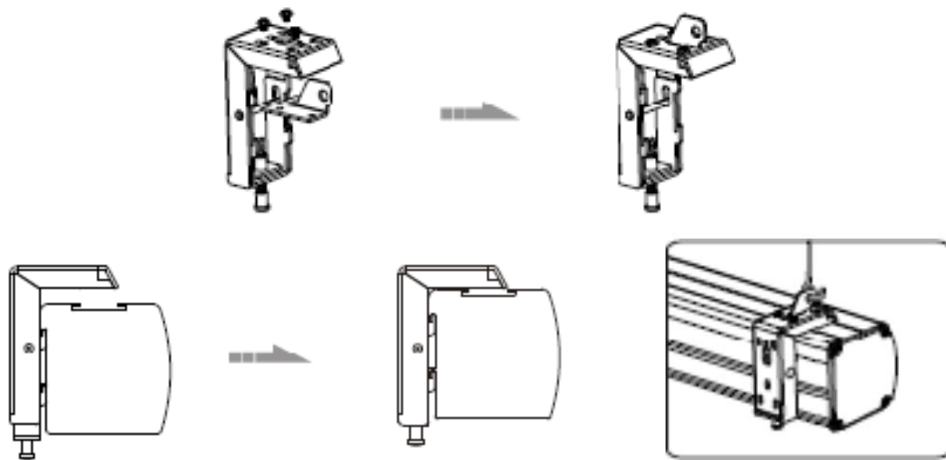

3. In preparation to put the screen on the brackets, loosen the fixing screw on each bracket to lower the baffle. Make sure any shipping tape or screws have been removed from the weight bar.



4. Now place the screen on the baffle hooks making sure they latch onto the screen casing. Then tighten the fixing screws on the bottom of each bracket to lock the screen onto the brackets.



5. The screen should now be securely mounted to your installation surface.

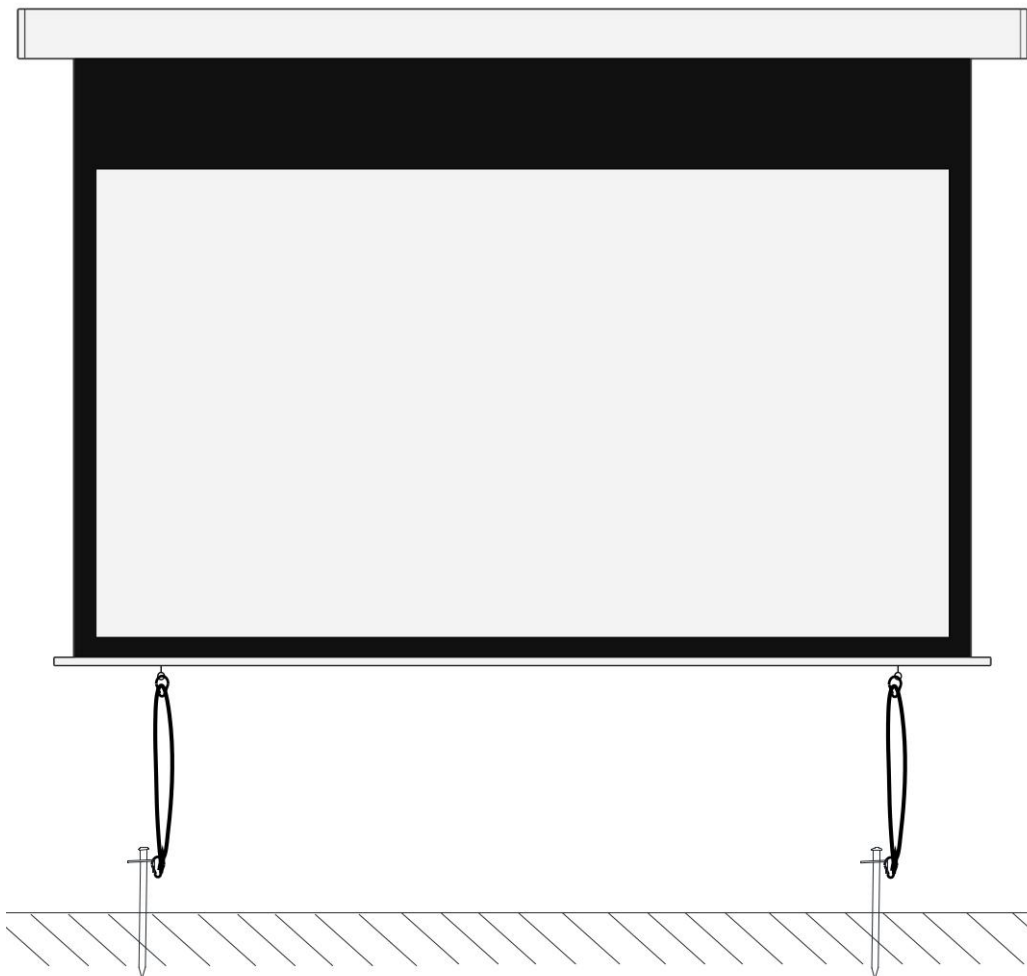

6. To prevent the screen from blowing in the wind when it is extended, use the provided rope and stakes to secure the bottom bar.

Controlling the Screen

The RF remote control will work up to 65' from the screen, if there are no obstructions. Keep the remote away from high temperatures and humidity. Change the battery when the signal is low.

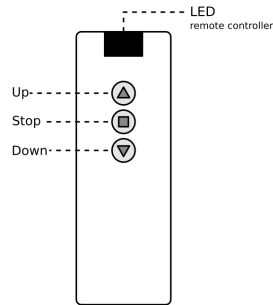

Appendix A: Adjusting the Screen Limits

We only recommend that experienced AV installers adjust the motor limits of the projection screen. The upper limit should never be adjusted - it controls the point at which the screen stops retracting into the case and is factory-set to flush. Improperly adjusting the limits of the motor will cause damage to the screen and motor and will void all warranty. Severtson Screens is not responsible for any damage caused by adjusting limits for any reason.

Always make small adjustments and test before continuing.

Limit adjustment controls may vary. It is the responsibility of the installer to verify drop and retraction limit controls.

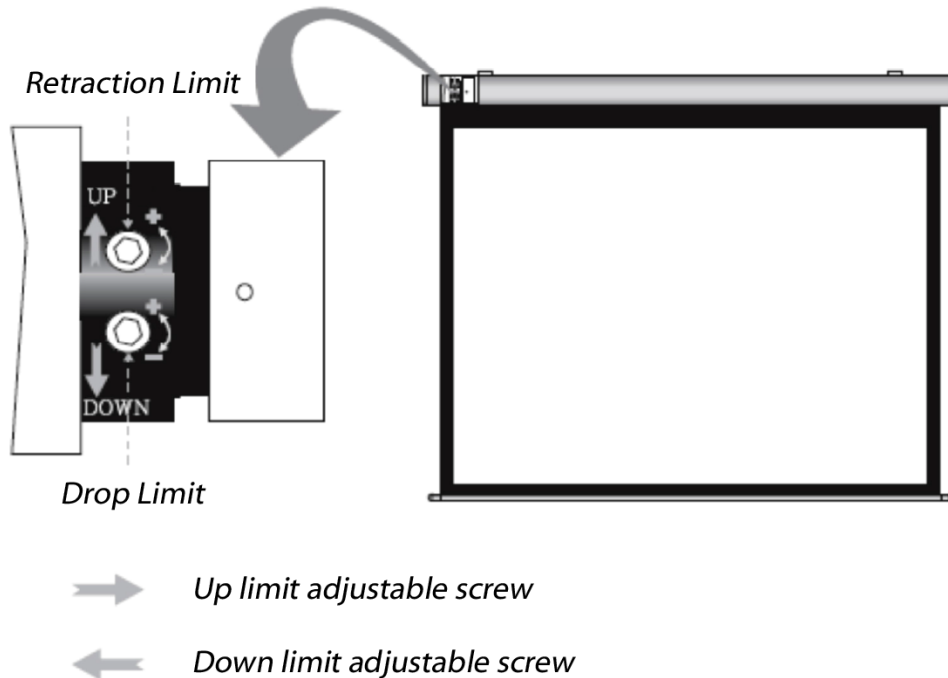

1. Remove the small rubber stopper on the underside of the screen case near the left-side of the case and extend the screen enough to be able to locate the limit controls inside the screen case.
2. Identify the upper (retraction) and lower (drop) limit switches and then adjust the appropriate limit according to the respective steps below. In some cases, the drop and retraction limit screws may be reversed, so it is crucial that small adjustments be made to verify the correct screw is being adjusted.
3. To adjust the up limit (*this should usually not be adjusted since it is factory-set*):
 - a. Bring the screen to the down position.

- b. Press “up” on the remote control.
 - c. If the screen does not fully ascend into the case use the accessory tool to adjust the up limit. Turn the Up limit towards the “+” symbol until the screen is at the desired position.
 - d. If the screen ascends too far then simply turn the same positioning screw towards the “-“. Make only minor adjustments and test the new limits in small increments, as the screen will not move when making this adjustment.
4. To adjust the down limit:
- Make sure to test the screen between each small adjustment.**
- a. Bring the screen to the up position.
 - b. Press “down” on the remote control.
 - c. If the screen does not fully drop to your desired position from the case use the accessory tool to adjust the down limit. Turn the Down limit towards the “+” symbol until the screen is at the desired position.
 - d. If the screen drops too far then simply turn the same positioning screw towards the “-“. Make only minor adjustments and test the new limits in small increments, as the screen will not move when making this adjustment.

Appendix B: Troubleshooting the Screen

The Outdoor Electric Series screens are designed for many years of use. Problems are usually simple to resolve and caused by small issues or improper end use. If problems persist, please contact us.

General Troubleshooting:

| | |
|--|---|
| Screen does not retract. | Power cable is not connected or outlet does not have power. Check the connection of the power cable. |
| Screen goes too low or does not go down enough. | Adjust the lower limit as described in <i>Appendix A: Adjusting the Screen Limits</i> . |
| Screen goes too far into case or does not ascend to the correct position. | Adjust the upper limit as described in <i>Appendix A: Adjusting the Screen Limits</i> . |
| RF remote does not work. | Check the batteries in the remote. Check to make sure you are in RF remote range. |

Warnings

1. Do not attempt to take apart or modify the screen. If any problems occur please contact your local dealer.
2. The screen is designed to be transported, stored, and operated in the horizontal position. Do not stand the screen up on its end vertically for any extended period of time.
3. Do not clean the screen case with water - only dust the screen to avoid electric shock.
4. Make sure the brackets used are firmly secured to the wall or ceiling to avoid any damage.
5. Make sure fixing screws are tight to avoid any damage.
6. When installing electric motors use a professional or contact your local dealer. Incorrect connection of wires may result in leaks or fires.
7. Fluorescent lights may cause interference with infrared signal.
8. Be careful not to scratch or damage the screen surface while handling it.
9. Do not write or draw on screen surface. Do not poke, fold, or tear screen material.
10. Never attempt to clean a coated screen with soap or water. If cleaning is necessary, use a damp cloth and dab the affected area lightly. A cotton cloth can be used to gently wipe dust off of the screen.
11. Do not use detergents or harsh chemicals to clean screen material. A soft cloth and mild soap can clean dust and dirt off a non-coated screen material. A cotton cloth can be used to gently wipe dust off of the screen.
12. Retract the screen after each use.
13. To prevent unnecessary damage, the assembly and maintenance of the screen should be done by adults.



Ignoring the safety warnings may lead to injuries and/or damaging the product.



Brackets should be installed in a secure place to avoid accidents caused by the screen falling.



Please contact your local dealer for repairs or maintenance. Please contact our company if you have any further questions.

Use caution when installing or removing the screen. Loose parts may cause the screen to fall.